



# Site Planning Guide

Siemens Magnetom Aera  
MRO4



# Table of Contents

1. Introduction
2. Environmental Requirements
3. Support Pad Requirements
4. Access Route & Turning Radius
5. Electrical Requirements
6. Magnetic Shielding
7. Telephone & Computer connection
8. Water connection
9. Airflow Requirements
10. Transport vehicle Requirements

# 1. Introduction

This medical trailer requires specific site preparations by the operator at each desired location.

This guide contains information about the necessary preparations of the site, before placement and connections of the medical trailer. The site must meet these requirements before the mobile unit can function properly.

## 2. Environmental Requirements

The minimum area required for parking the trailer is:

Length= 16,050 m

Width= 7,550 m

The ground and the access way must be clearly paved. In order to ensure proper operation of the stabilizing system the ground must be level. The maximum variation is 1% (which is 0,6 degree).

Make sure that the patient lift, stairs and belly compartments are easily accessible for patient entry and services.

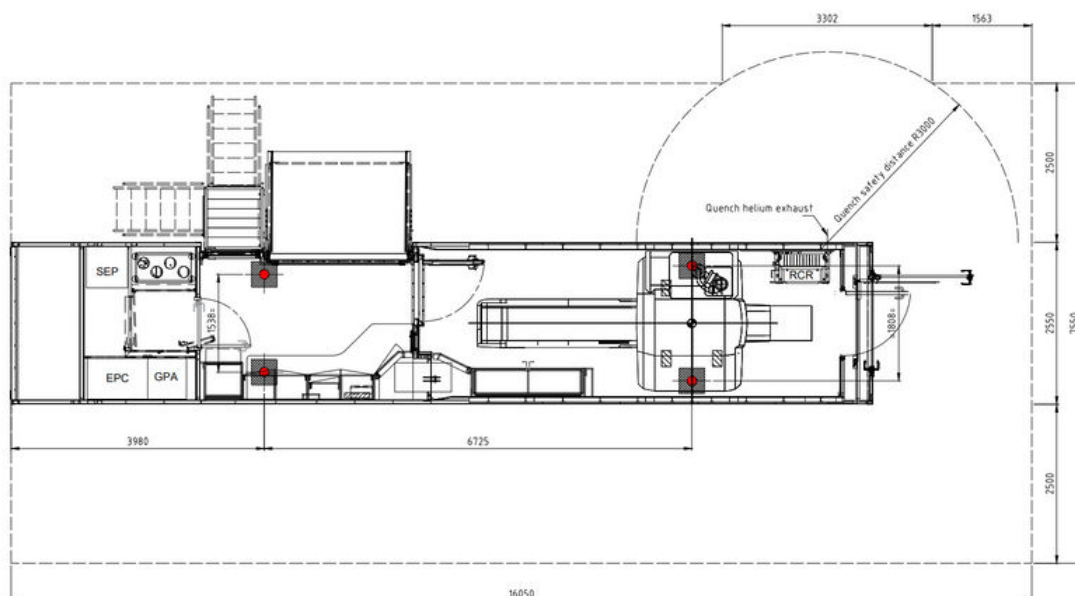

Please refer to above drawing for an overview of the dimensions and weight of the trailer.

# 3. Support Pad Requirements

The ground and access way must be able to carry the weight of the trailer and transport vehicle.

The weight of the trailer is approximately 27 000 kg.

The nylon support blocks of 0,4 x 0,4 m must be placed under the support legs. The ground under each support leg must be able to carry the load of the trailer.

Please refer to below drawing for the positions of the support legs of the trailer.

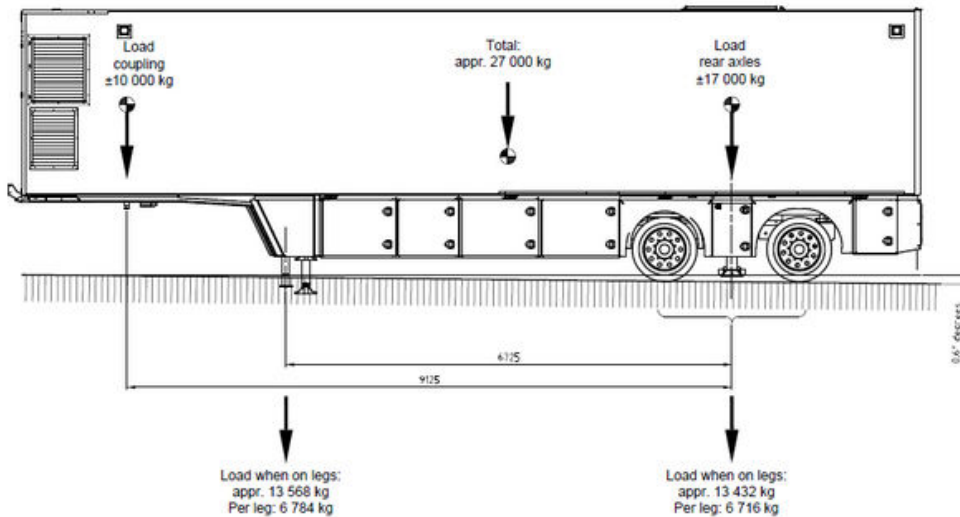

# 4. Access Route & Turning Points

The access route must have a minimum width of 7,2 m. The radius of the turning circle must have an outer radius of 12,5 m and an inner radius of 5,3 m of the turning circles.

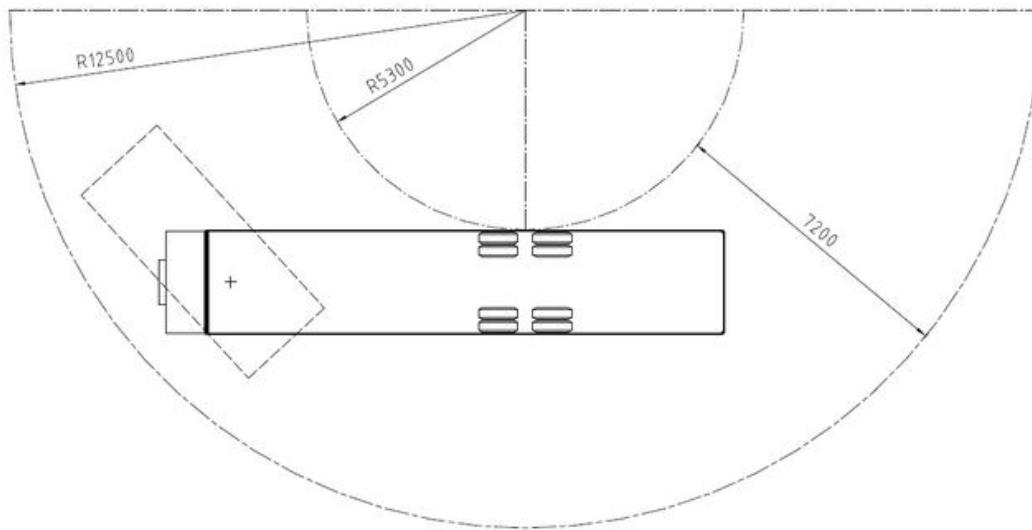

# 5. Electrical Requirements

The trailer is equipped with a 400 volt 3 phases 50 Hz electric system according to the TN-S system.

The site must provide a 400 V, 50 Hz, service fused at the following capacities:

		Fuse rate:
1.	Siemens Aera MRI	200 A

# 5. Electrical Requirements

The electrical phase rotation of the supply should be L1 L2 L3.

A 15 meter shoreline cable, wired directly to the trailer, is provided for connecting the mobile unit to local power.

As the main cable cannot withstand the wear and tear of traffic passing over it, the site must provide necessary protective ramps, catenary systems or other means to protect the cable where it traverses roads or pathways.

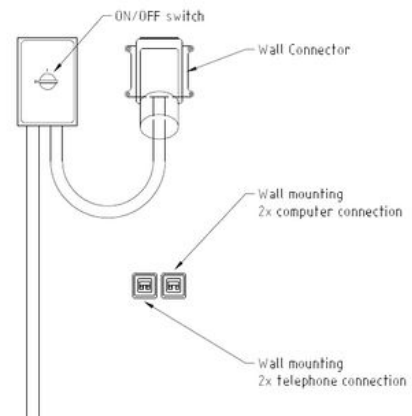

The shoreline cable is provided with a with a 380 V - 250 A Marechal DS2 male connector with 2 parts:

- 1) Marechal part # 39 28 017: Inlet (male)
- 2) Marechal part # 392A 013: Handle

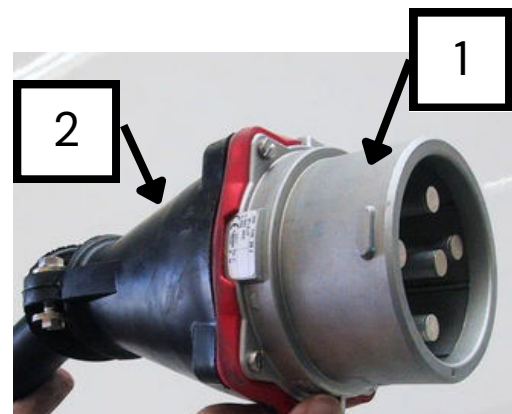

The customer facility must have the suitable Marechal female connector to match this connector.

The electric installation must provide a dedicated medical earth terminal to ensure the earth connection to the trailer.

The site must ensure that the female plug is earthed before the male plug is connected.

# 6. Magnetic Shielding

The trailer is equipped with magnetic shielding. The shielding will keep the magnetic field outside the trailer walls below 0.5 mT. You may find stronger field on the roof.

Inside the trailer, close to the magnet, the magnetic field is higher than 0.5 mT. These areas are restricted for people with pacemakers and magnetic items. These areas are marked with safety signs, provided by the MR manufacturer.

# 7. Telephone & Computer connection

2 telephone sockets (RJ45 type) and 4 computer sockets (RJ-45) are provided as standard on the trailer.

The trailer can be connected to the hospital IT network. The site must supply cables for connecting to the IT network.



# 8. Water connection

The trailer is equipped with a water tank for supply of water to the air humidifier.

The water tank is located in the belly compartment of the trailer.  
The tank can be filled by the filler cap.

# 9. Airflow Requirements

The acceptable thresholds for airflow are 1000 mm from the grills placed on the outside wall.

The condenser system is situated at the front of trailer.

A 0.6x0.44 m grill is located on the left side of the trailer. This grill is for the quench pipe of the magnet and must remain clear. The grill must remain clear, allowing the helium gas to evaporate.

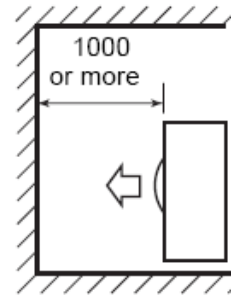



# 10. Transport vehicle Requirements

The connections points to the transport vehicle are placed at the front side of the trailer.

- Brake system – duomatic coupling
- ABS/EBS system
- Lights 24V ISO N
- Lights 24V ISO S

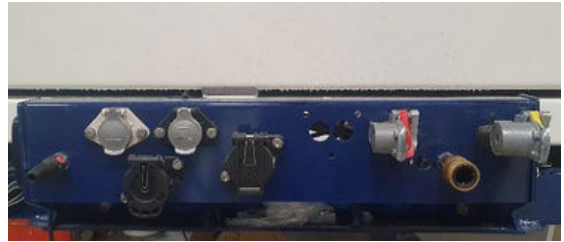

The couplings on the transport vehicle must match the couplings of the trailer.

The site is responsible for providing a transport vehicle that has a towing capacity sufficient for the trailer. Please refer to the dimensions & weight drawing in chapter 2.

The coupling height of the transport vehicle must match the coupling height of the trailer. The coupling height is 1,20 m.

The trailer is equipped with a 2" coupling pin.

The transport vehicle must have the matching fifth wheel coupling.

The transport vehicle must have a minimum permissible load on the king pin of 10 000 kg.

